

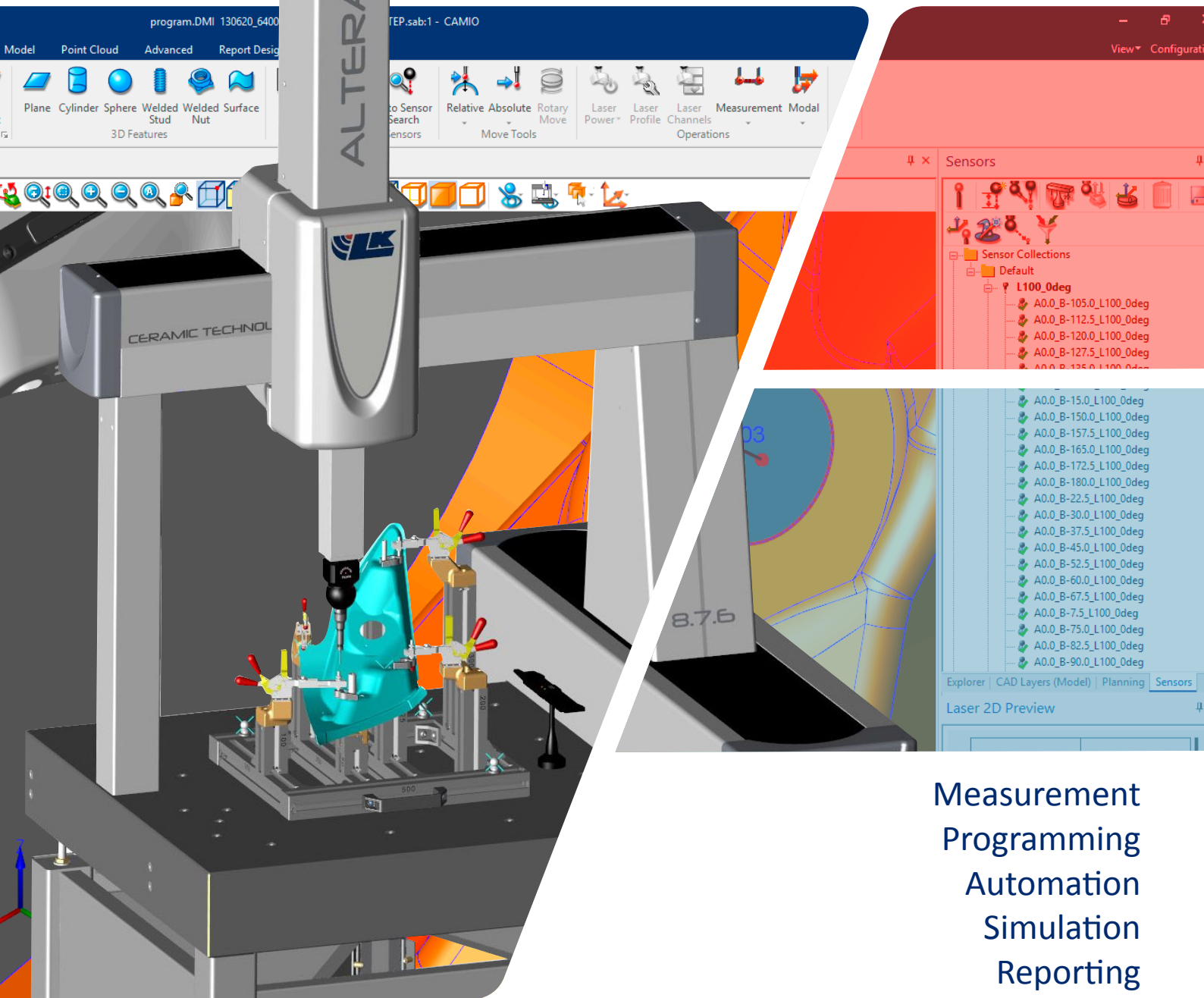

CAMIO

CMM TECHNOLOGIES SOFTWARE



Measurement
Programming
Automation
Simulation
Reporting

...we are metrology



Market Leading Innovation



LK Metrology is renowned for innovative CMM hardware and software solutions, and has been credited with many industry firsts, including the first bridge-style CMM, first high accuracy horizontal arm CMM and first software developed specifically for CMMs.

Our technologies underpin the process chain from design, development, production and assembly through to quality assurance in global industries such as automotive, aerospace, defence, motorsport, energy, medical and contract inspection.

This combination of technology and expertise enables us to develop solutions that provide unique and proven capabilities. CAMIO has core competencies that provide real enhancements to benefit each stage of a production process. By leveraging these benefits to improve product quality, reduce cost and accelerate lead times, manufacturers gain a real and measurable competitive advantage.

CONTENTS

2-3	About Us
4-5	Software Interface
6-7	Programming
8-9	Reporting
10-11	Program Editor
12-13	Simulation
14-15	Automation

To be competitive in a global market manufacturers need to take full advantage of the most efficient, innovative and capable technologies.

Whether a small company with one CMM or large organisation with multiple installations, CAMIO provides a CMM software solution to match your business requirements and safeguard your investment.

CAMIO has in-depth programming, analysis and reporting capabilities for a wide range of CMM applications - all features are tightly integrated into a single platform using proven technology and the latest developments in CMM software.

CAMIO encourages users to drive the inspection process graphically, everything from part alignment, feature inspection and dimensional tolerancing is much faster and more intuitive when users work with CAMIO's advanced user interface.

Novice users find the step-through approach to CMM inspection particularly easy to master and quickly migrate to the more progressive features of the software. More experienced users appreciate the advanced functionality and high-level DMIS language with conditional program execution and user macros.

Inspection Toolbar

Software icons grouped by inspection task for ease of use

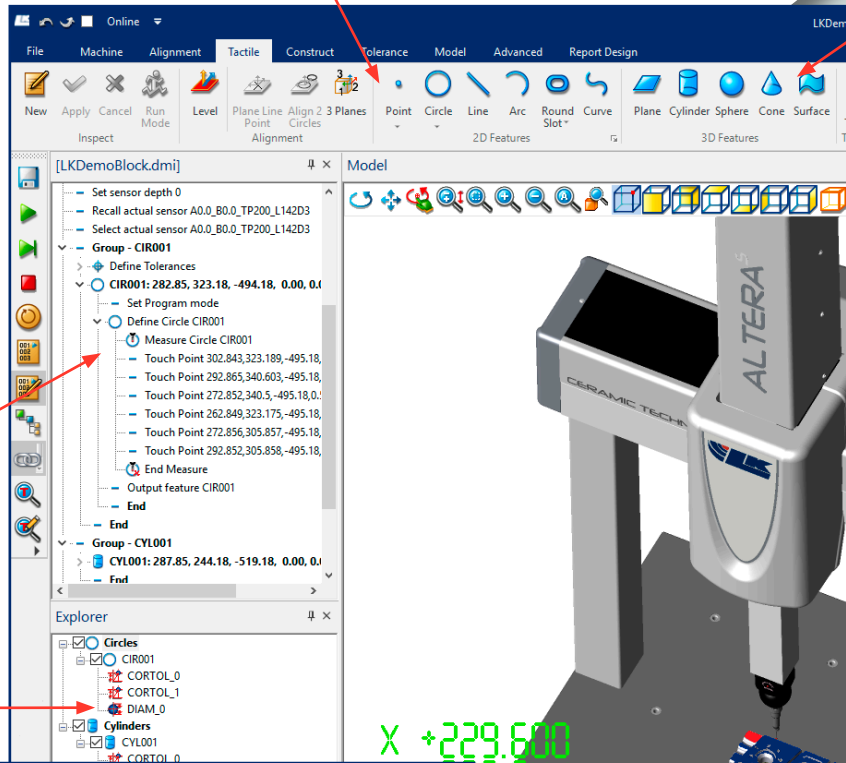

Program Editor

Create programs online or offline using CAD or CMM teach & learn

Inspection Database

Explore the measured features, datums and associated tolerances

On-line Help

Context-sensitive help with tutorials and search-by-topic

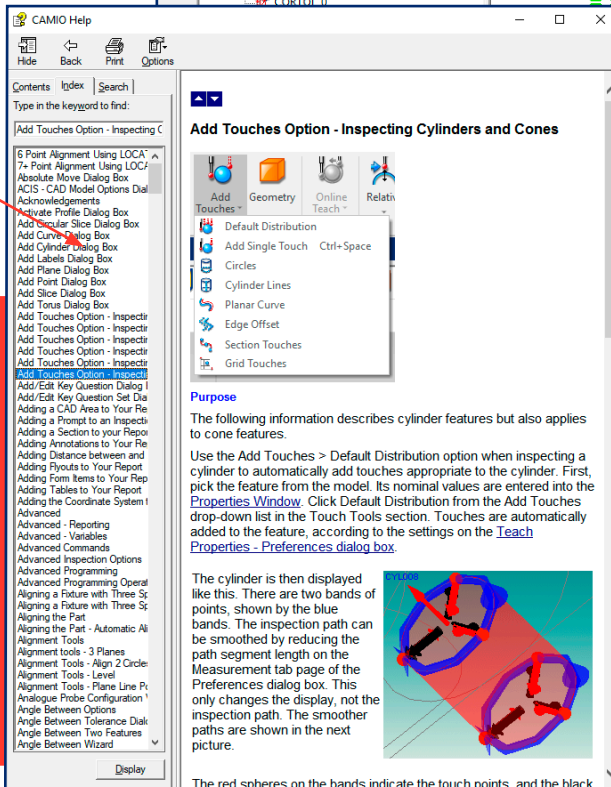

Workpiece CAD

Workpiece and fixture CAD models for program simulation

Software Interface

Workspace

Activity-based workspace with configurable layout and toolbars

CMM Simulation

Full simulation with probe path verification and collision detection

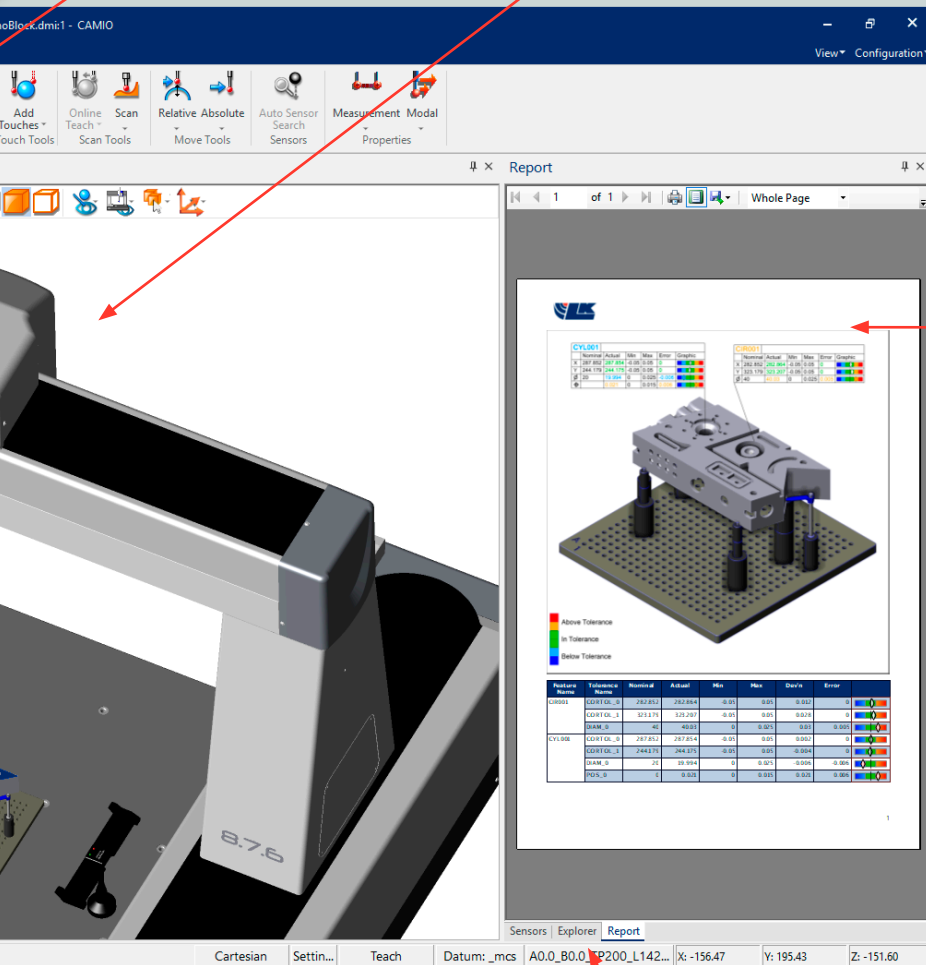

Instant Report

Real-time reporting with user configured content and layout

Localisation

International language support including English, French, German, Italian and Simplified Chinese

CAD INTEROPERABILITY

CAMIO support for popular native and natural CAD formats

CAD format	read file	write file
ACIS*	.sat, .sab	.sat, .sab
CATIA V4	.model, .exp, .session	.model
CATIA V5	.CATPart, .CATProduct	.CATPart, .CATProduct
CATIA V6	.CATPart, .CATProduct	-
IGES*	.igs, .iges	.igs, .iges
NX	.prt	-
Parasolid	.x_t, .x_b,	-
ProE / Creo	.prt, .asm	-
SolidWorks	.sldprt, .sldasm	-
SolidEdge	.par, .asm, .psm	-
STEP*	.stp, .step	.stp, .step
VDA-FS	.vda	-
JT	.jt	-
DXF/DWG	.dwf, .dwg	-

*CAD format supported by CAMIO as standard, other CAD formats are optional extras - file write not supported

COMPLIANCE

CAMIO has been verified according to following organisational CMM standards:

- DMIS 5.3 (Dimensional Metrology Standard Consortium)
- PTB 5.32 CMM software algorithms (Physikalisch-Technische Bundesanstalt)
- ISO 1101:2017 Geometric Dimensioning and Tolerancing (International Organization for Standardization)
- ASME Y14.5:2018 Dimensioning and Tolerancing (American Society of Mechanical Engineers)

CAMIO provides a powerful suite of graphical programming tools for 3D measurement - including online and offline programming, CAD and non-CAD applications and multi-sensor technology.

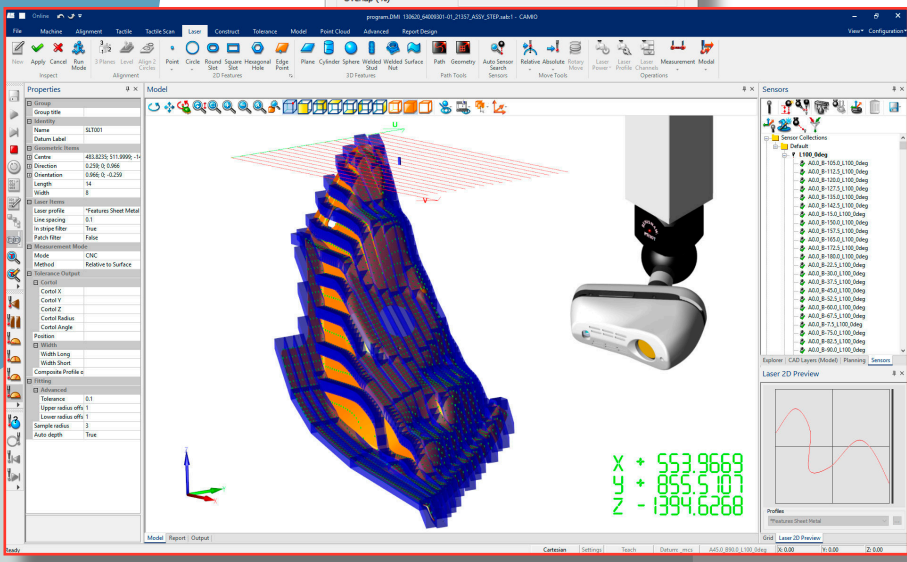
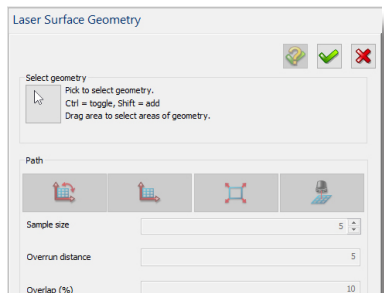
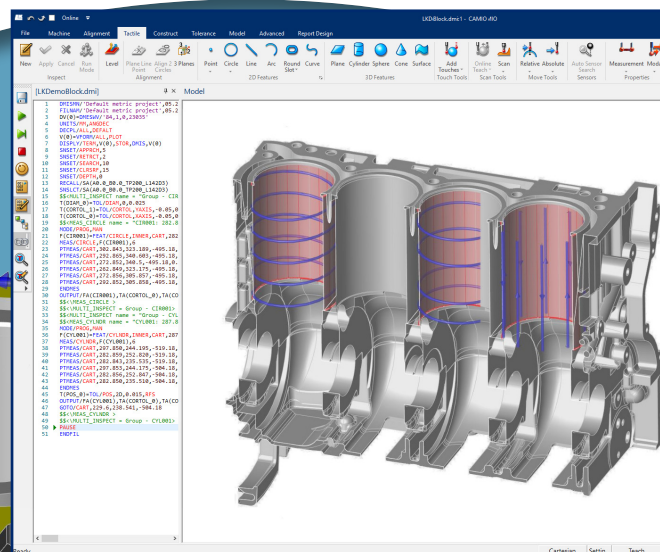
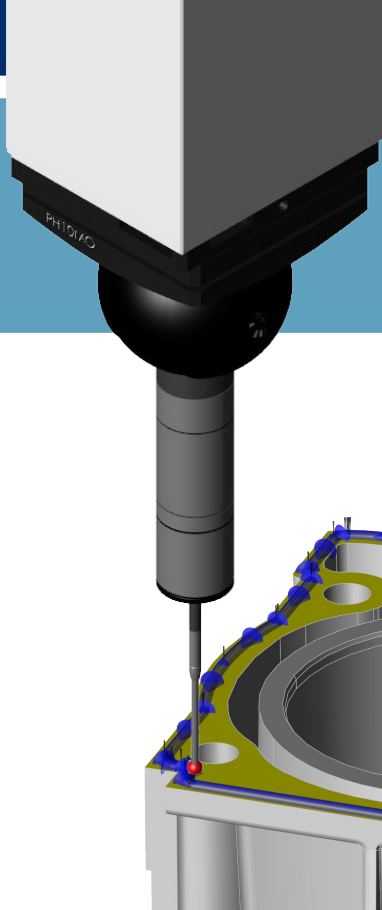

Laser Scanners

Laser scanners are used for freeform parts and semi-rigid materials, CAMIO programming functionality includes:

- Feature measurement
- Point-cloud simulation
- 3D continuous scanning
- Field-of-view simulation
- Laser line setting
- Filters and meshing

Programming

Scanning Probes

Scanning probes are ideal for high accuracy profile and form measurement, CAMIO programming functionality includes:

- Feature scan
- Section scan
- Offset edge
- Data filters
- Feature algorithms
- Sampling frequency

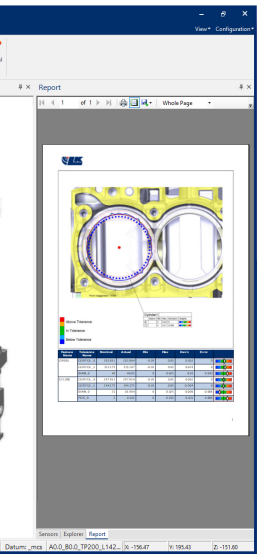

CAMIO's advanced feature-based and point cloud-based programming routines simply complex inspection tasks by linking functions and applying specialized measurement sequences – from manual non-CAD programming to advanced 3D multi-path scanning methods using CAD.

Intelligent workflows optimise the programming session, with critical information and related functionality readily available at every step, and group feature dependencies and associated tolerancing to further streamline the process.

Probe Builder

CAMIO includes a library of accessories for defining probe assemblies

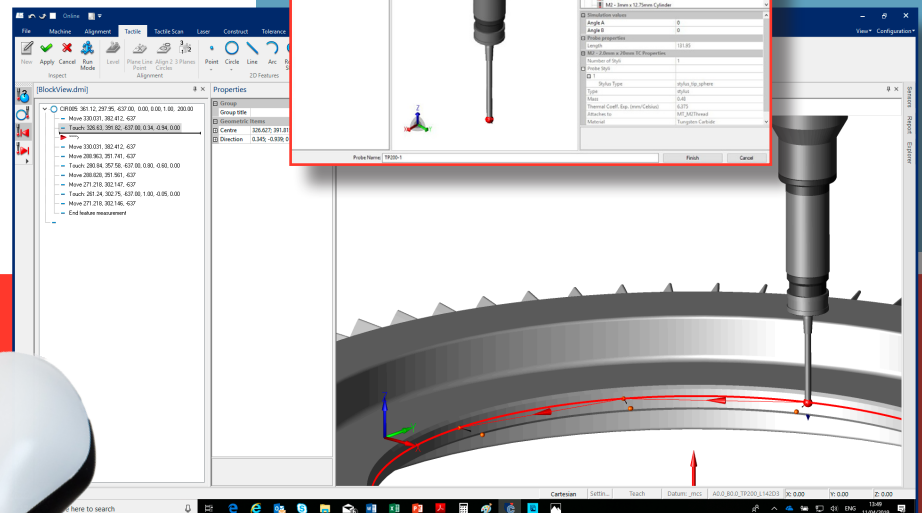
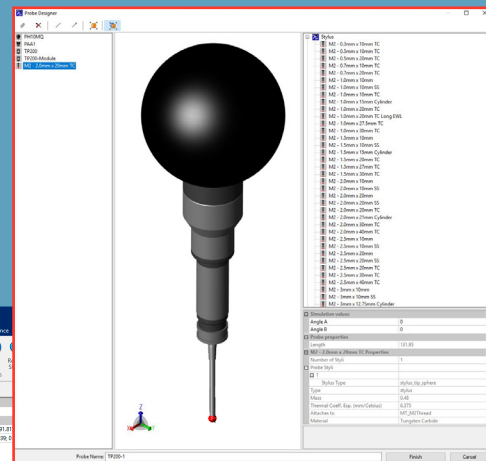

Teach & Learn Programming

CAMIO Teach & Learn allows programmers to conveniently update programs online, and create new programs for non-CAD applications using the CMM handbook.

CAMIO enables manufacturers to analyse measurement data and share meaningful reports across multiple platforms - while keeping quality records safe for future reference.

4 Cylinder Engine Block
11/04/2019 09:40

Form exaggeration: 100x

Cylinder1

Dev'n	0	0.006
0	0.006	

4 Cylinder Engine Block
11/04/2019 09:40

PLN001 A

Datum	Min	Max	Deviation	Graphic
0	0.1	0.003		

CYL001 B

Datum	Min	Max	Deviation	Graphic
0	0.02	-0.003		

CYL002 C

Datum	Min	Max	Deviation	Graphic
0	0.02	0.004		
A, B	0	0.1	0.001	

Report Content

- GD&T flyouts
- Output table
- Form plots
- Colour deviation scale
- Multiple views per page
- CAD model or digital image
- Text box
- Customer logo
- Page header and footer
- Section profile

Feature Name	Type	Datums	Min	Max	Dev'n
CYL001	∅	A	0	0.1	0.006
CYL002	∅	A, B	0	0.02	-0.003
CYL005	∅	D, E, F, G	0	0.02	-0.004
CYL006	∅	D, E, F, G	0	0.05	0.014
CYL007	∅	D, E, F, G	0	0.02	0
PLN001	□		0	0.05	0.001

Reporting

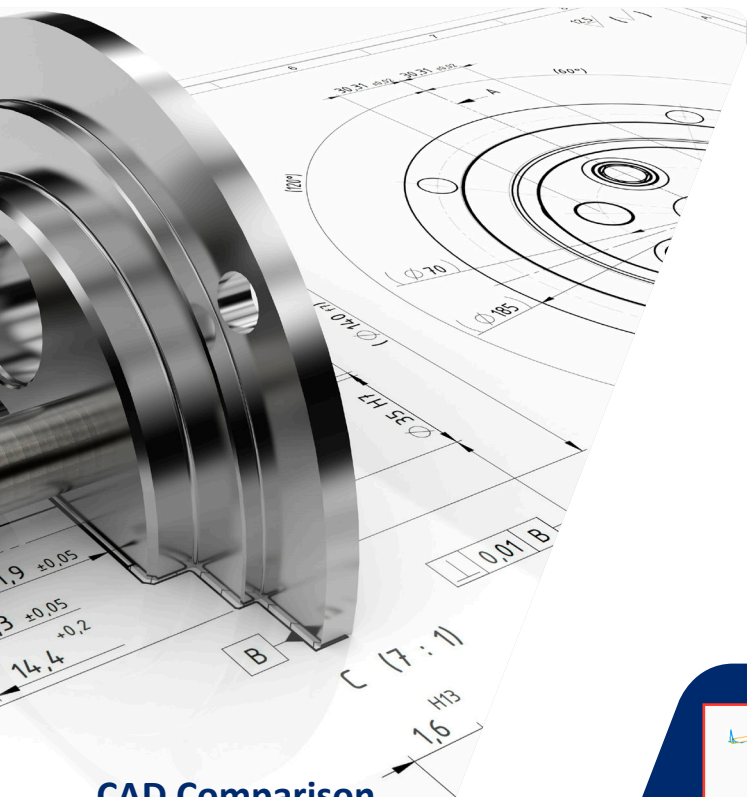

CAMIO provides a flexible inspection reporting solution to fit around your current process, while providing new possibilities.

Instant reports give real-time access to quality data, enabling you to take informed decisions sooner.

Standard templates provide countless reporting possibilities for a range of applications, and the capability to customise reports and create individual layouts.

When more creativity is needed a powerful report editor puts content rich output and drag & drop capability at your fingertips.

Should you need to further analyse your measurement results the inspection database stores your data safely in a convenient central location.

CAD Comparison

- Instant evaluation of surface deviation
- Further investigate areas of interest
- Annotate dimensions and tolerances
- Best-fit analysis and reporting

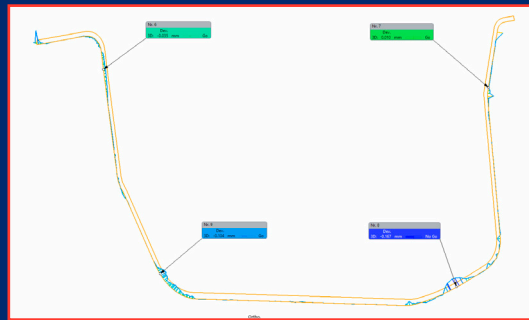

Section Profile

- Multiple section profiles
- Minimum/maximum point deviation
- Visualise profile tolerances
- Section data feature construction

OUTPUT FILES

CAMIO supports several output file formats as standard

Format	Extension
Portable Document Format	.pdf
Comma Separated Values	.csv
Extensible Markup Language	.xml
Data Manipulation Language	.dml
DMIS Out File	.dmo

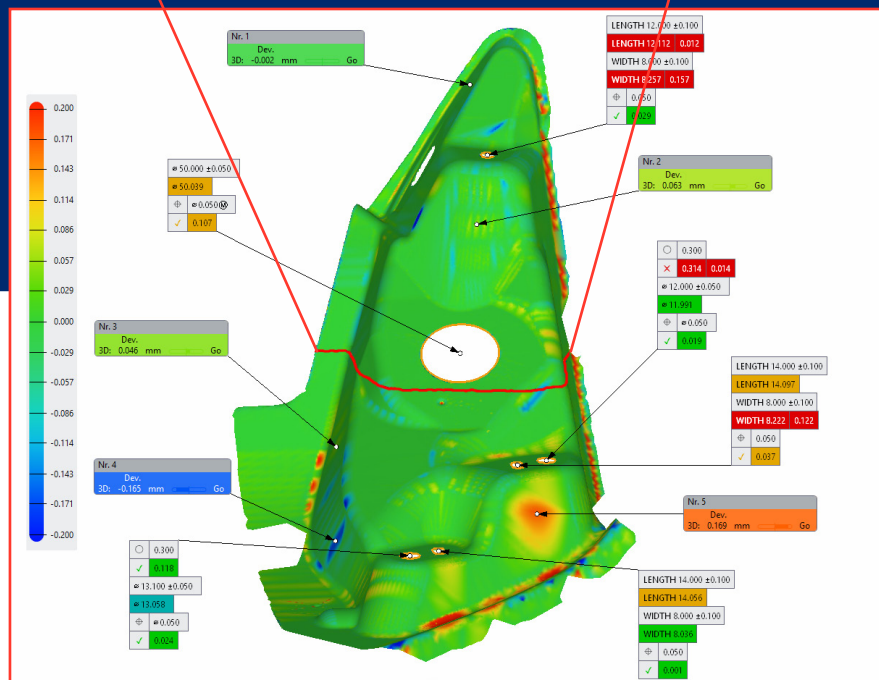

CAMIO gives you the freedom to generate programs using the programming technique you prefer - online and offline using CAD, or teach and learn using the CMM handbox.

CAMIO provides the flexibility of different programming styles and two program editors - an easy to use block view of inspection objects with familiar drag & drop capability, and a more powerful DMIS editor for in-depth programming - both support native DMIS programs and are 100% compatible.

To safeguard your investment in inspection programs, CAMIO's program interoperability ensures forward compatibility of your CMM programs. Allowing you to migrate from older versions of software including 3rd party software, and upgrade your hardware without having to rewrite your DMIS programs.

Inspection Objects

Associated measurement blocks for simplicity

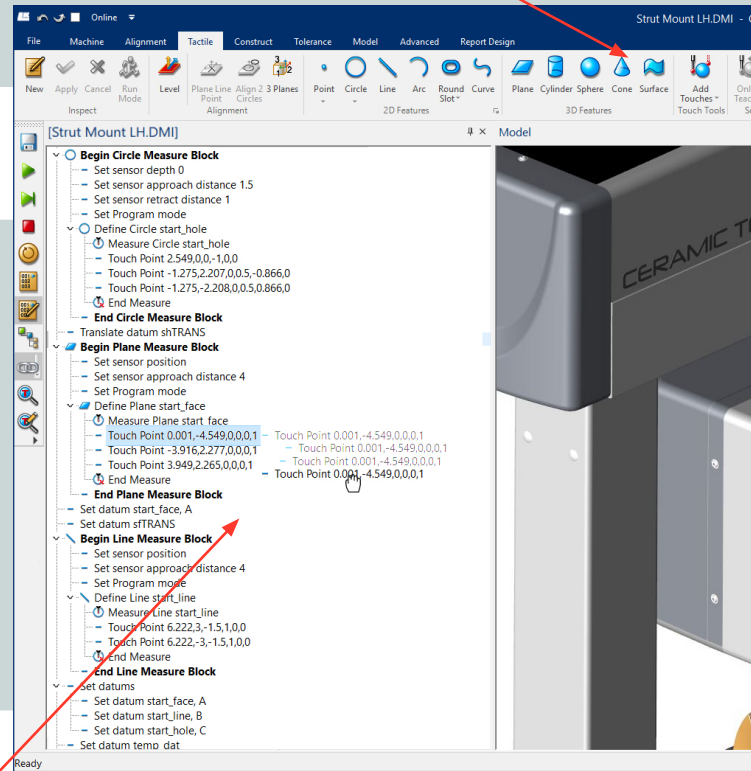

Drag & Drop

Familiar Windows drag & drop capability

DMIS text

Edit commands directly using the DMIS text editor

PROBE CHECK

CAMIO provides powerful visualization tools for editing programs, previewing changes and debugging new programs.

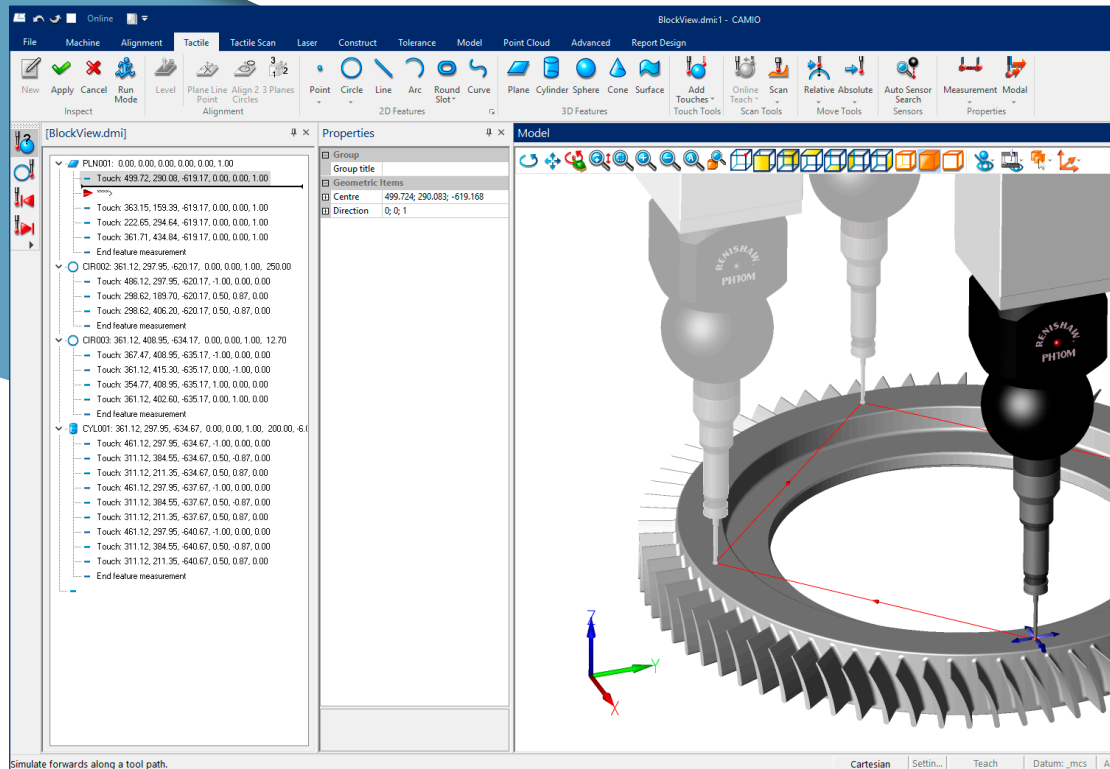

Program Editor

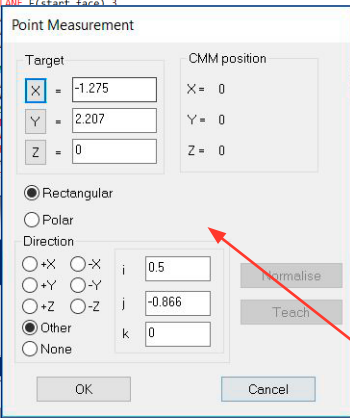
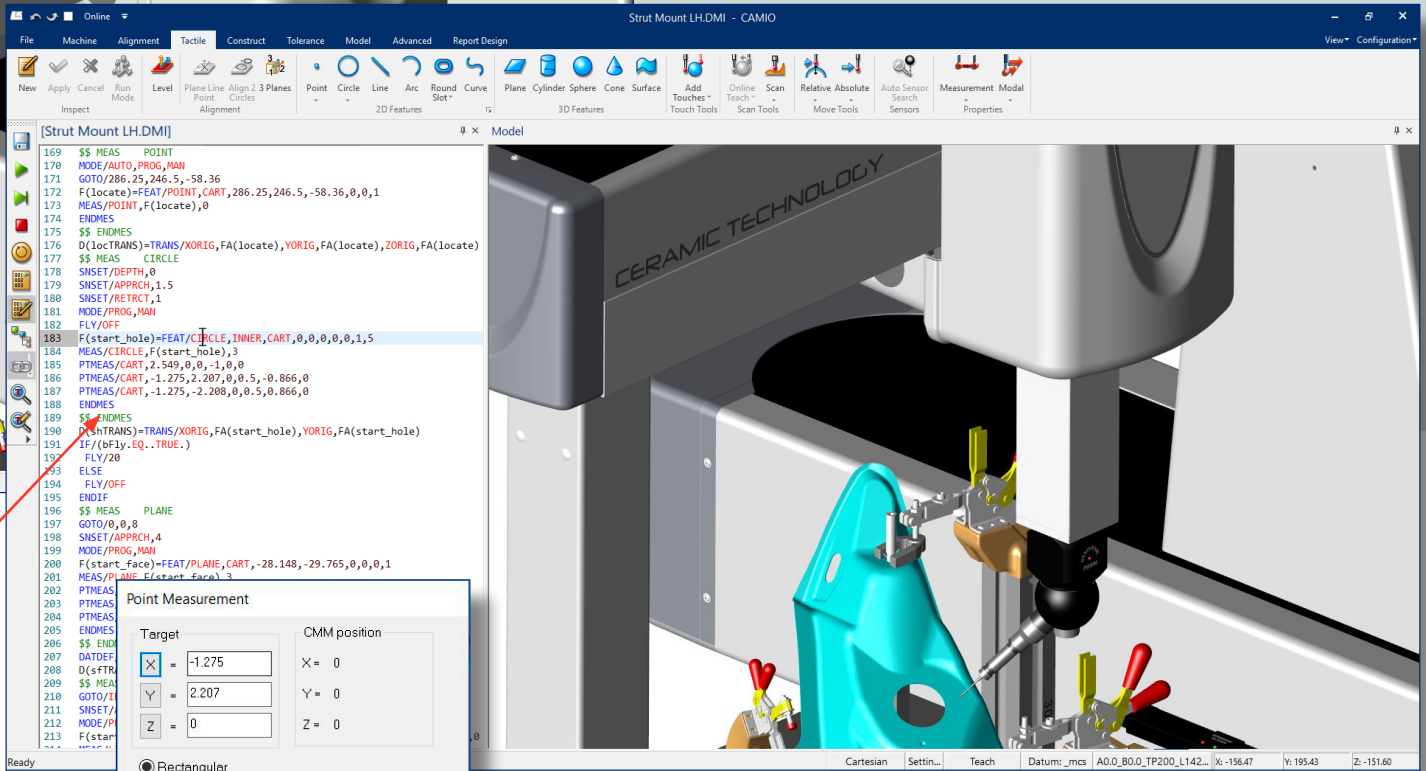
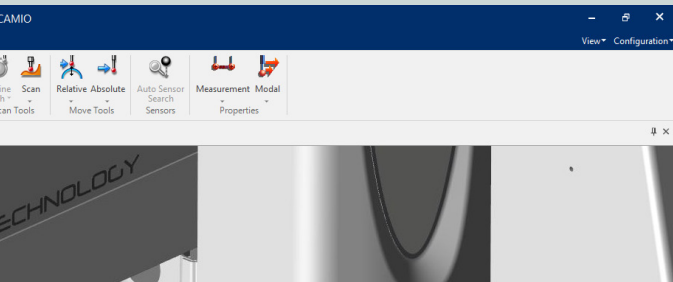

DMIS window

Context dialog boxes for editing DMIS commands

HIGH-LEVEL LANGUAGE

CAMIO high-level commands extend the capability of your CMM program beyond inspection – with advanced functions including conditional program execution based on variable parameters such as measurement results, operator input and external data.

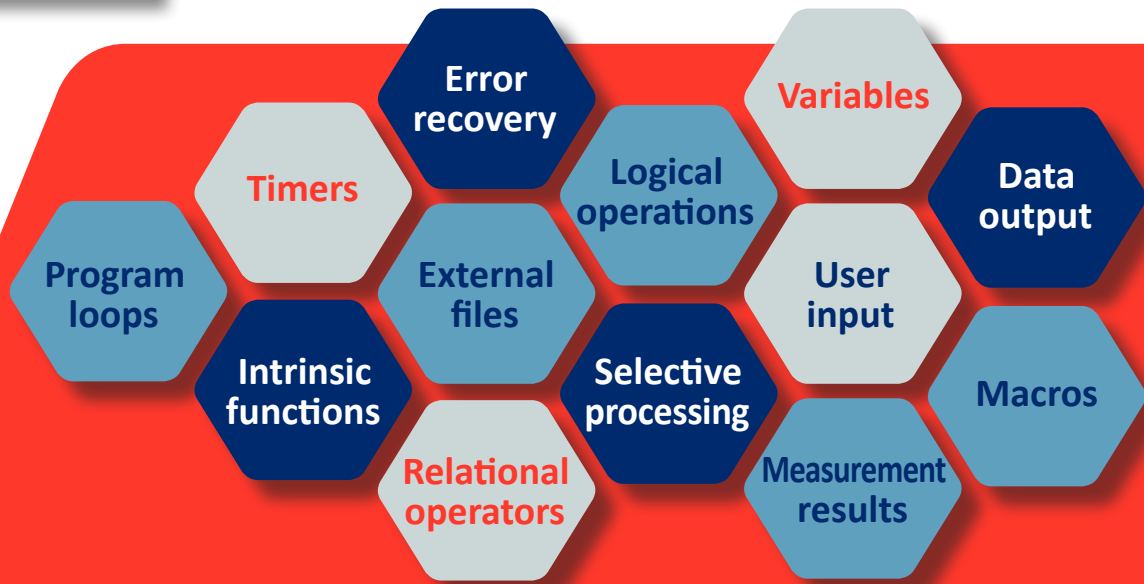

CAMIO simulation allows programmers to fully prepare programs and optimise measurement sequences offline – ensuring programs are ready before parts arrive for inspection, and dramatically reducing CMM downtime when proving out programs.

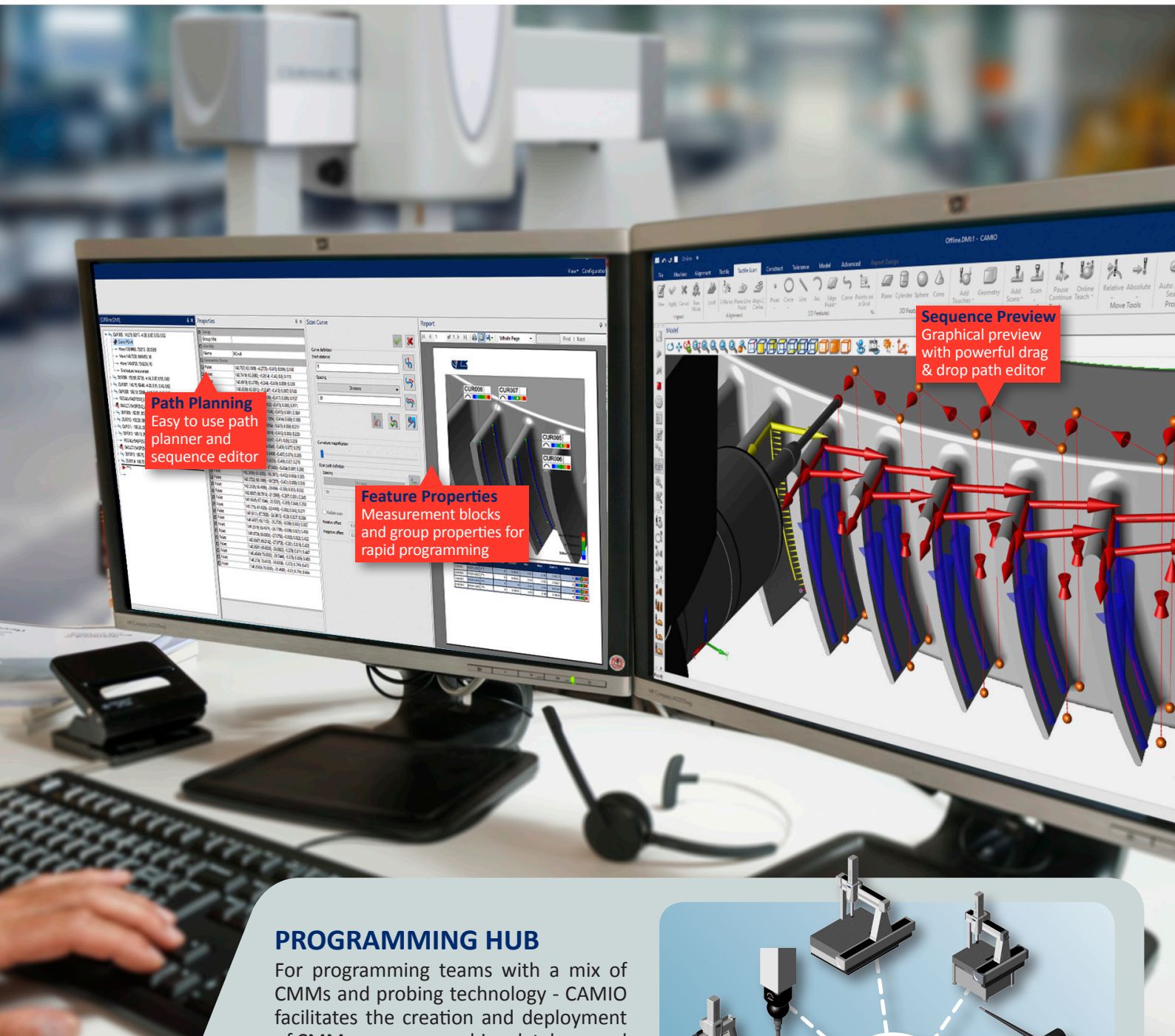

Path Planning
Easy to use path planner and sequence editor

Feature Properties
Measurement blocks and group properties for rapid programming

Sequence Preview
Graphical preview with powerful drag & drop path editor

PROGRAMMING HUB

For programming teams with a mix of CMMs and probing technology - CAMIO facilitates the creation and deployment of CMM programs, probing database and report templates from a central location.

- Virtual CMMs including non LK models
- Library of touch probes, scanning probes, laser scanners and accessories
- CMM specific program templates and configuration settings
- Native DMIS language CMM programs
- Master probe and calibration database



Simulation

CAMIO's virtual CMM provides a realistic offline CMM programming environment, with accurate CMM and probe motion sequences for collision detection and cycle time estimations.

Several levels of simulation are available including CMMs library's, multi-sensor probing, multiple work-piece models, holding fixtures, change racks and rotary tables.

Optimisation

Automatic optimisation of measurement sequences

COLLISION DETECTION

Automatic collision detection allows for a safe working distance between the moving virtual CMM and workpiece models.

Probe collisions and near misses are detected automatically and corrected offline before the program is sent to the CMM for use online.

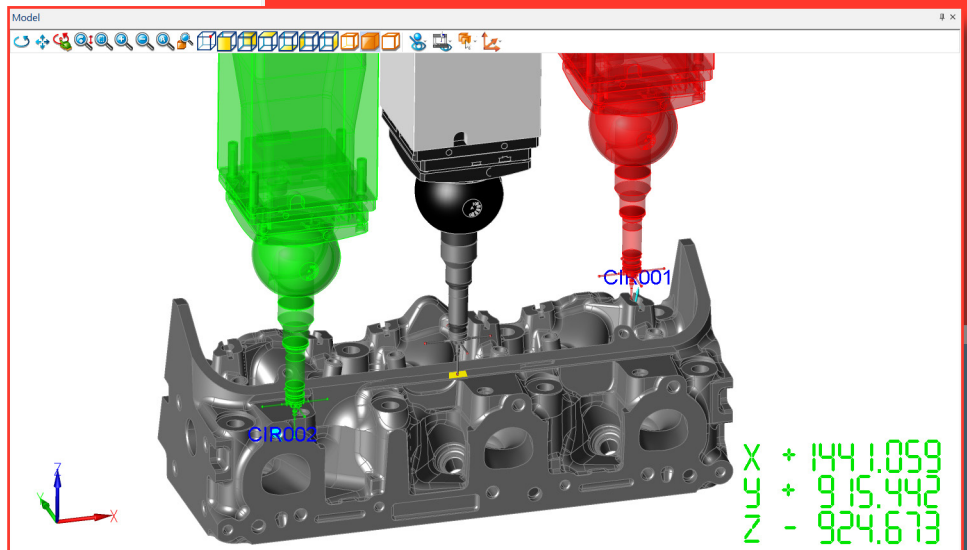
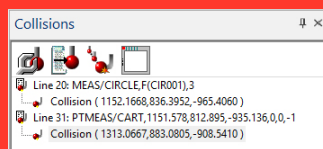

CAMIO automation software provides a modular solution for CMM automation - with options to choose the level of CMM automation capability based on the application and setting.

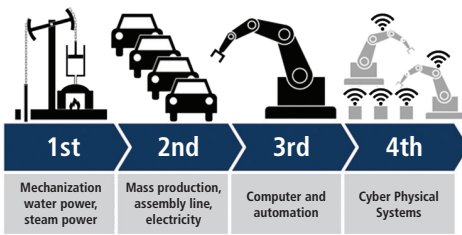

THE SMART FACTORY

Industry 4.0 defines what has been called the smart factory

Within a smart factory manufacturing systems communicate and cooperate with one another and humans. In-line measurement provides immediate feedback, enabling optimization of the process in real-time. Manufacturers benefit from, superior cost efficiencies, better quality products and higher productivity.

INLINE CMM AUTOMATION

In-line CMM automation allows manufacturing cells to increase product quality and production efficiency. The CMM is fully integrated in the cell with all sequencing managed by the cell control system and CAMIO8 automation software.

- Rapid detection of process variation enables corrective actions in real-time while maintaining the flow of production.
- Automatic monitoring of the manufacturing cell for a quick response should the unexpected occur.
- Personnel and equipment safeguarded by presence detection devices and other safety equipment.

AUTOMATION BENEFITS



Increase
productivity



Reduce
costs



Improve
quality



Closed-loop
manufacturing



Centralized
data

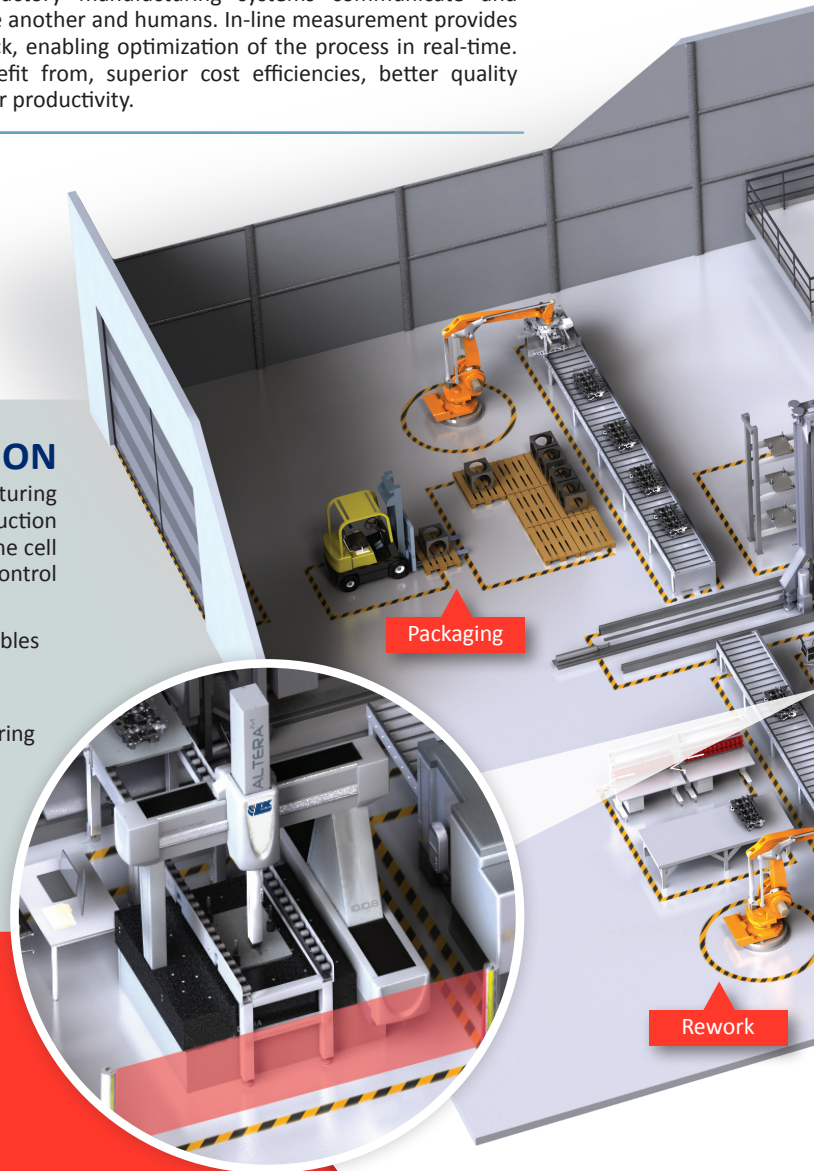

Automation

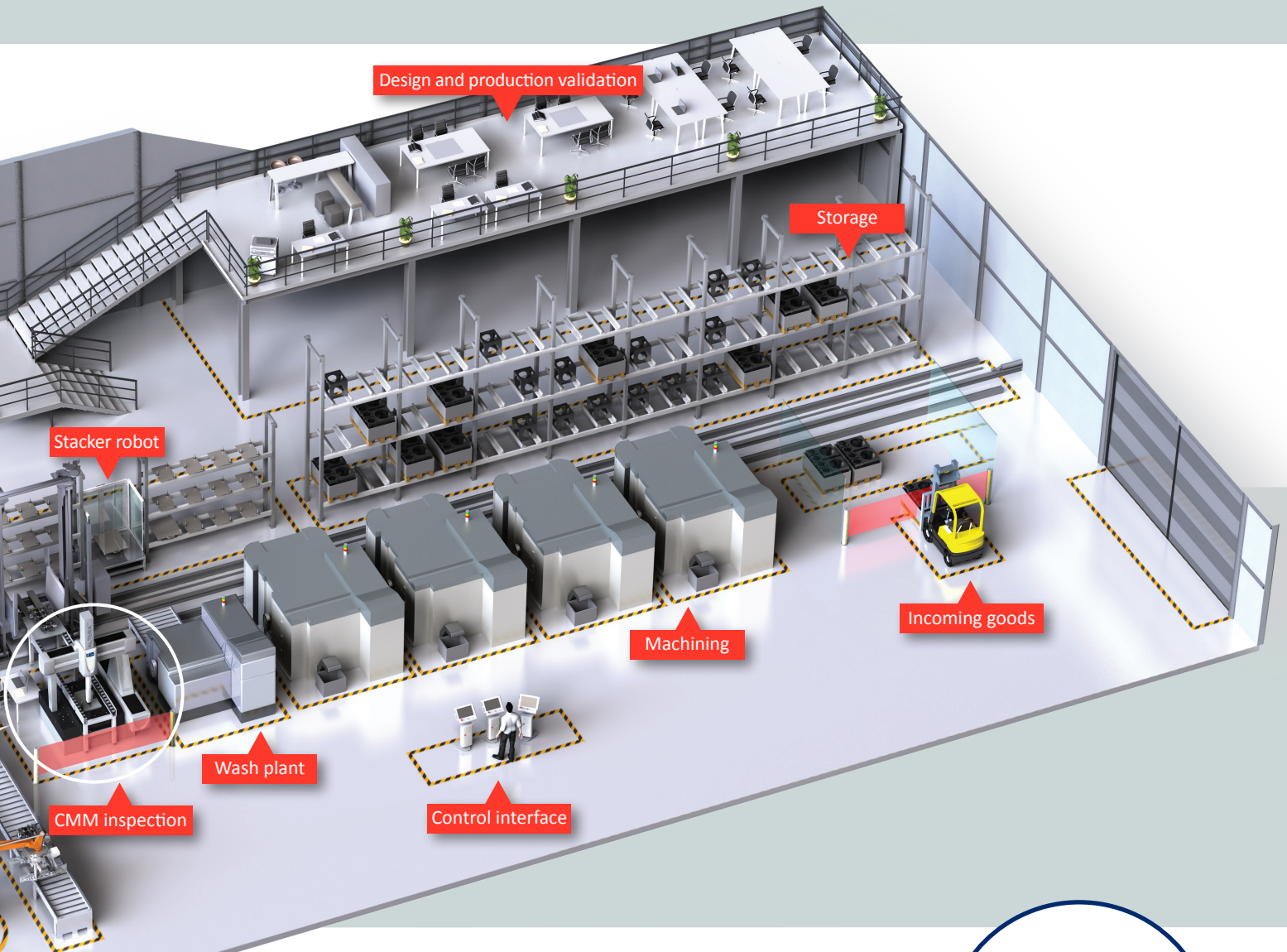

STAND-ALONE CMM AUTOMATION

Stand-alone CMM automation increases utilisation and makes the CMM an easy to use quality tool for production operators. The CMM is controlled by an operator with support from CAMIO automation software.

- Intuitive program menu allows users with minimal training to operate the CMM safely.
- Optimisation of part loading and program execution keeps the CMM measuring efficiently and with minimal delays between tasks.
- Running the CMM is made easy by input devices such as bar code readers and RFID tags for part identification.

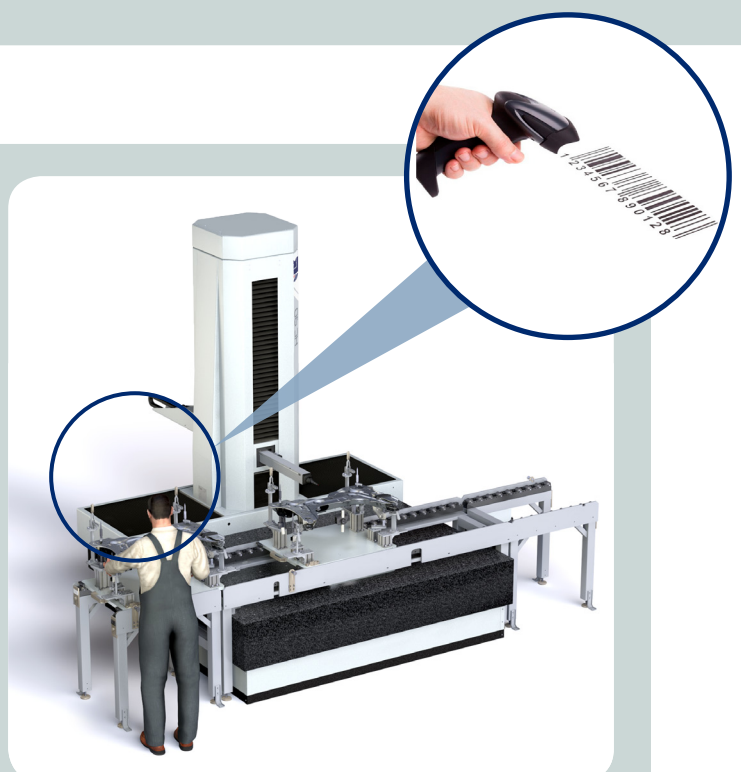



LK METROLOGY Ltd.
Argosy Road, East Midlands Airport,
Castle Donington, Derby,
DE74 2SA United Kingdom
Tel: +44 (0)1332 811138
Email: Sales.UK@LKmetrology.com

LK METROLOGY Inc.
29550 W. K. Smith Drive, Unit B
New Hudson, MI 48165
United States
Tel: + 1 (810) 263 6100
Email: Sales.US@LKmetrology.com

LK METROLOGY China Co. Ltd.
Room 401, HuaTeng Building, No. A302,
Jinsong 3rd Zone, Chaoyang District, Beijing,
P.R. of China.
Tel: +86 10 87768860
Email: Sales.China@LKmetrology.com

LK METROLOGY Europe S.r.l.
Corso Orbassano, 402/16
10137 Torino, Italy
Tel: +39 011 0743945
Email: Sales.Italy@LKmetrology.com

LK METROLOGY Benelux
Technologielaan 11,
3001 Leuven, Belgium
Tel: +32 (0)16 387550
Email: Sales.Belgium@LKmetrology.com

LK METROLOGY Gmbh
Siemensstrasse 24,
D-63755 Alzenau, Germany
Tel: +49 6023 9292617
Email: Sales.Germany@LKmetrology.com

LK METROLOGY SAS
1 Rue Guynemer - Bâtiment B6/B8
78114 Magny Les Hameaux (Paris)
Tel: +33 (0)1 77048480
Email: Sales.France@LKmetrology.com

www.LKmetrology.com